

**MOC3020 MOC3021
MOC3022 MOC3023**

PACKAGE DIMENSIONS

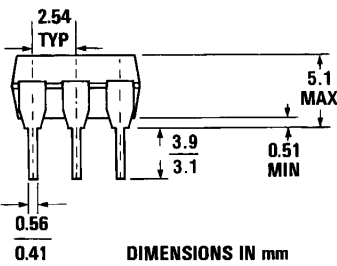

ST1603

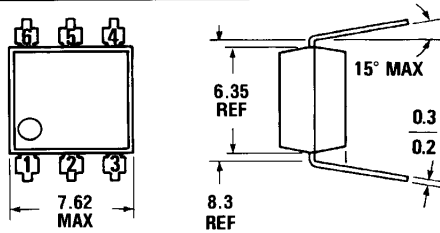
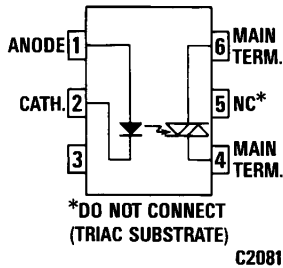

Equivalent Circuit

DESCRIPTION

The MOC3020, MOC3021, MOC3022 and MOC3023 are optically isolated triac driver devices. These devices contain a GaAs infrared emitting diode and a light activated silicon bilateral switch, which functions like a triac. This is designed for interfacing between electronic controls and power triacs to control resistive and inductive loads for 240 VAC operations.

FEATURES

- Excellent I_{FV} stability—IR emitting diode has low degradation
- High isolation voltage—minimum 7500 VAC peak
- Underwriters Laboratory (UL) recognized—File #E90700

APPLICATIONS

- European applications for 240 VAC
- Triac driver
- Industrial controls
- Traffic lights
- Vending machines
- Motor control
- Solid state relay

ABSOLUTE MAXIMUM RATINGS

TOTAL PACKAGE

Storage temperature	-55°C to 150°C
Operating temperature	-40°C to 100°C
Lead temperature (soldering, 10 sec)	260°C

INPUT DIODE

Forward DC current	50 mA
Reverse voltage	3 V
Peak forward current (1 μ s pulse, 300 pps)	3.0 A
Power dissipation (25°C ambient)	100 mW
Derate linearly (above 25°C ambient)	1.33 mW/°C

OUTPUT DRIVER

Off-state output terminal voltage	400 Volts
On-state RMS current (Full cycle, 50 to 60 Hz)	$T_A=25^\circ\text{C}$ 100 mA $T_A=70^\circ\text{C}$ 50 mA
Peak nonrepetitive surge current (PW=10 ms, DC=10%)	1.2 A
Total power dissipation (25°C ambient)	300 mW
Derate above 25°C	4.0 mW/°C



NON-ZERO-CROSSING TRIACS

ELECTRO-OPTICAL CHARACTERISTICS (25°C Temperature Unless Otherwise Specified)

INDIVIDUAL COMPONENT CHARACTERISTICS

CHARACTERISTIC	SYMBOL	MIN.	TYP.	MAX.	UNITS	TEST CONDITIONS
INPUT DIODE						
Forward voltage	V_F		1.2	1.50	V	$I_F = 10 \text{ mA}$
Junction capacitance	C_J		50		pF	$V_F = 0 \text{ V}$, $f = 1 \text{ MHz}$
Reverse leakage current	I_R			100	μA	$V_R = 3.0 \text{ V}$
OUTPUT DETECTOR						
Peak blocking current, either direction	I_{DRM}	—	10	100	nA	$V_{DRM} = 400 \text{ V}$, Note 1
Peak on-state voltage, either direction	V_{TM}	—	2.5	3.0	Volts	$I_{TM} = 100 \text{ mA Peak}$

Note 1. Test voltage must be applied within dv/dt rating.

TRANSFER CHARACTERISTICS

DC CHARACTERISTICS	SYMBOL	MIN.	TYP.	MAX.	UNITS	TEST CONDITIONS	
LED trigger current (current required to latch output)	MOC3020	I_{FT}	—	—	30	mA	Main terminal voltage = 3.0 V, $R_L = 150\Omega$
	MOC3021	I_{FT}	—	—	15	mA	
	MOC3022	I_{FT}	—	—	10	mA	
	MOC3023	I_{FT}	—	—	5	mA	
Holding current	I_H	—	100	—	μA	Either direction	

TRANSFER CHARACTERISTICS

CHARACTERISTICS	SYMBOL	MIN.	TYP.	MAX.	UNITS	TEST CONDITIONS
dv/dt RATING						
Critical rate of rise of off-state voltage	dv/dt	—	12	—	V/ μs	Static dv/dt, $T_A = 85^\circ\text{C}$ (see Fig. 3)
Critical rate of rise of commutating voltage	dv/dt	—	0.2	—	V/ μs	Commutating dv/dt $I_{LOAD} = 15 \text{ mA}$ (see Fig. 4)

ISOLATION CHARACTERISTICS

CHARACTERISTICS	SYMBOL	MIN.	TYP.	MAX.	UNITS	TEST CONDITIONS
Isolation voltage	V_{ISO}	5300			V_{ACRMS}	$I_{IO} \leq 1 \mu\text{A}$, 1 Minute
	V_{ISO}	7500			V_{ACPEAK}	$I_{IO} \leq 1 \mu\text{A}$, 1 Minute
Isolation resistance	R_{ISO}	10^{11}			ohms	$V_{IO} = 500 \text{ VDC}$
Isolation capacitance	C_{ISO}		0.5		pF	$f = 1 \text{ MHz}$

Note 1: Ratings apply to either polarity of pin 6 — referenced to pin 4. Voltages must be applied within dv/dt rating.

TYPICAL ELECTRICAL CHARACTERISTIC CURVES

(25°C Free Air Temperature Unless Otherwise Specified)

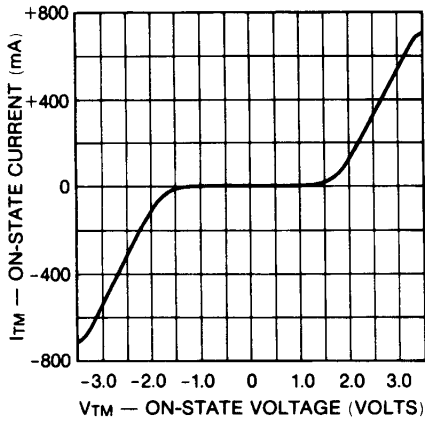

C1711

Fig. 1. On-State Characteristics

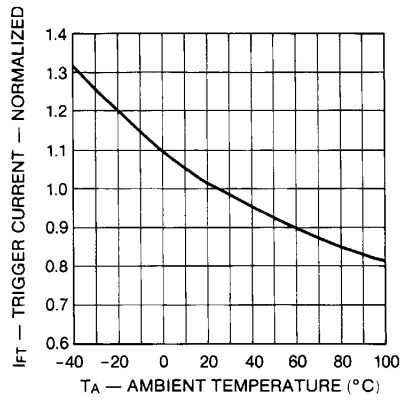

C1712

Fig. 2. Trigger Current vs. Temperature

TEST CIRCUITS FOR dV/dt MEASUREMENTS

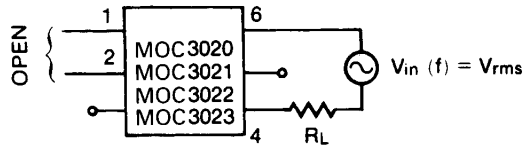

$$\frac{dV}{dt} = \omega V_{\text{pack}} = 2\pi f \times 1.414 V_{\text{rms}}$$

$$= 8.88 f V_{\text{rms}}$$

Fig. 3. Static dV/dt

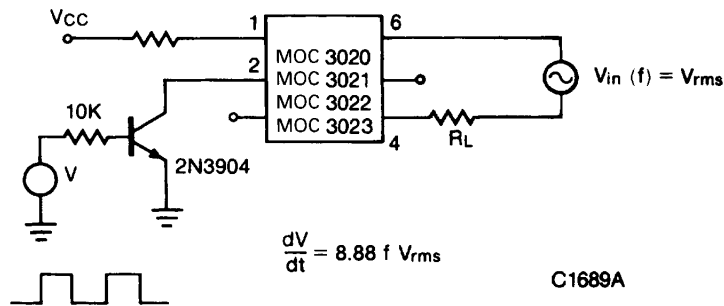

$$\frac{dV}{dt} = 8.88 f V_{\text{rms}}$$

C1689A

Fig. 4. Commutating dV/dt